

Spherical roller bearings, cylindrical and tapered bore

Principal dimensions			Basic load ratings		Speed ratings		Designation
d	D	B	dynamic C	static C0	Reference speed	Limiting speed	
mm			kN		r/min		
340	520	133	2812	4550	1000	1300	* SKF Explorer bearing 23068 CCK/W33 *

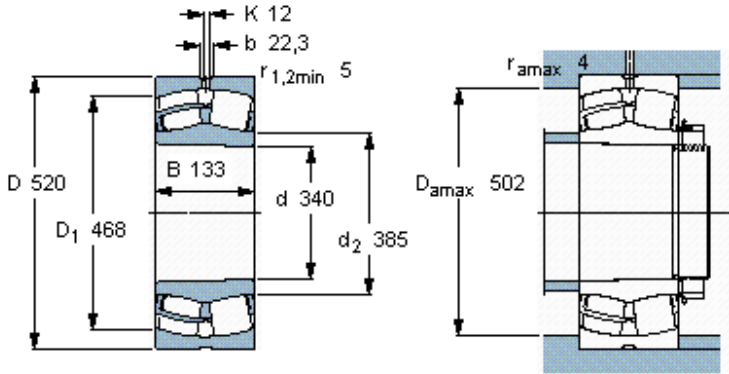

Tapered bore, taper
1: 12

Calculation factors

- e 0,24
- Y_1 2,8
- Y_2 4,2
- Y_0 2,8